

LIFT MASTER BOOM, ECONOMY BOOM, NON-TELESCOPING-LM-EBNT-6-24

APPROX WEIGHT: 298.62 lbs. DOES NOT INCLUDE WEIGHT OF POWER OR PACKAGING!!!

*** ANY ADDITIONS, DELETIONS, OR OMISSIONS MUST BE CORRECTED ON THIS DRAWING AS THIS DRAWING WILL BE CONSIDERED ALL INCLUSIVE ***
 ALL GRAPHICS PROVIDED ARE FOR REFERENCE ONLY. IF CERTAIN DIMENSIONS ARE CRITICAL PLEASE VERIFY THOSE DIMENSIONS WITH YOUR SALESPERSON

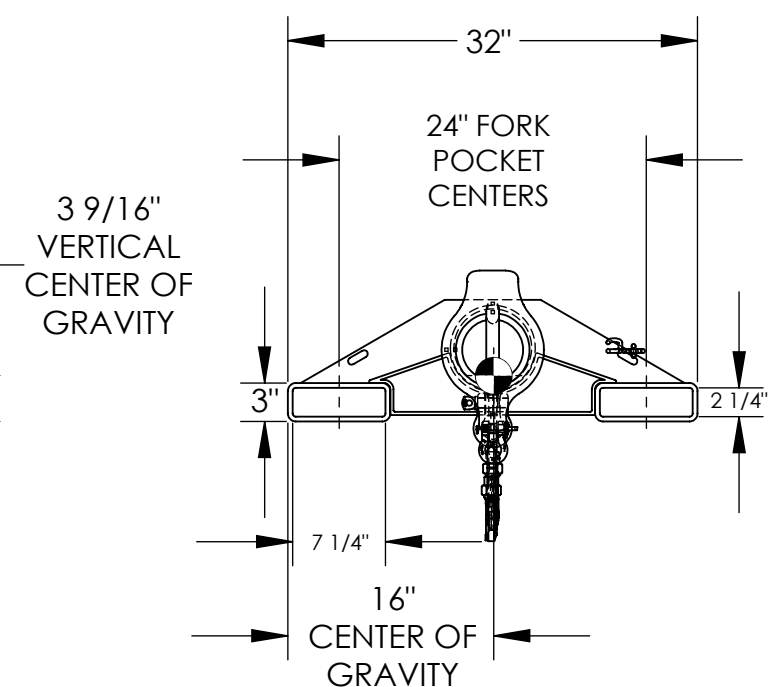
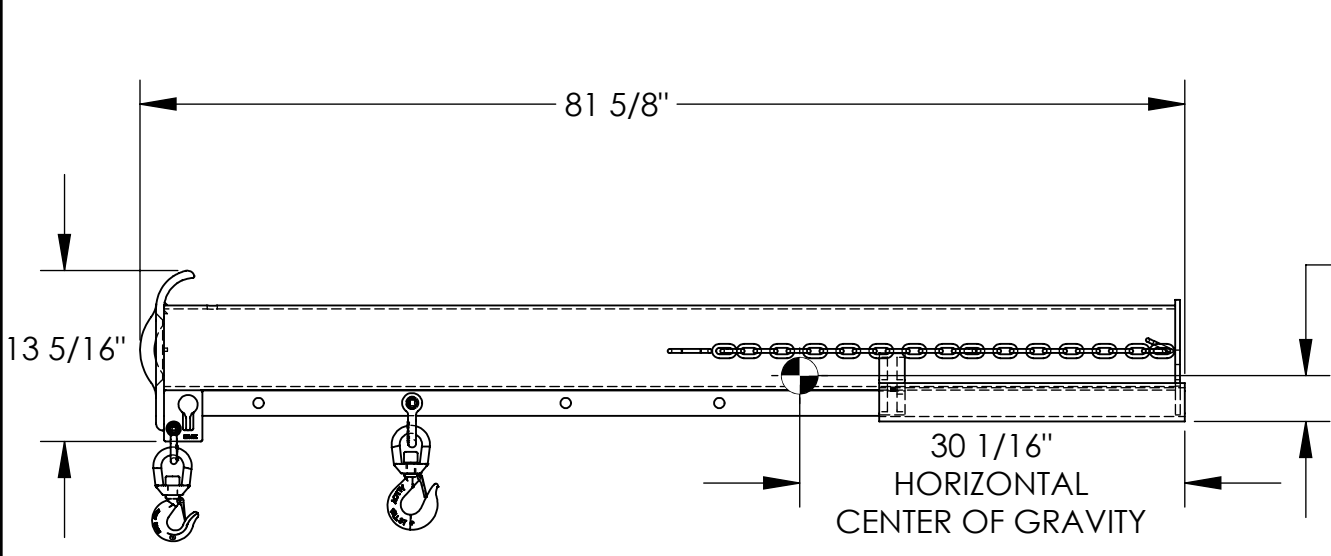

*--MAXIMUM SINGLE HOOK CAPACITIES

DISTANCE	36"	48"	60"	72"	79"
CAPACITY	6000	5000	4500	4000	3500

DIMENSION TOLERANCE ± 1/4"

STANDARD FEATURES

- MODEL NUMBER: LM-EBNT-6-24
- CAPACITY: 6,000 LBS
- OVERALL HEIGHT - 13 5/16"
- OVERALL LENGTH - 81 5/8"
- OVERALL WIDTH - 32"
- USABLE FORK POCKET - 2 1/4" X 7 1/4"
- 24" FORK POCKET CENTERS
- 36" MINIMUM HOOK POINT
- 79" MAXIMUM HOOK POINT
- TOUGH BAKED IN POWDER COATED BLUE FINISH

APPROX. WEIGHT / LOST LOAD = 298.62
 MINIMUM EFFECTIVE THICKNESS = LESS THAN 1"
 NEVER EXCEED LOAD CENTER
 RATING PER FORKTRUCK
 MANUFACTURERS GUIDELINES.
 DO NOT USE THIS FORK TRUCK
 ATTACHMENT IF LOAD WILL EXCEED
 FORK TRUCK MANUFACTURER'S
 LOAD CENTER RATING

SPECIAL FEATURES

NONE

APPROVAL	I, THE UNDERSIGNED, AGREE THAT THE PRODUCT AS REPRESENTED SATISFIES DESIGN AND DIMENSION REQUIREMENTS. I ALSO ACKNOWLEDGE MY DUTY TO CONFIRM PRODUCT AND INSTALLATION COMPLIANCE WITH ALL APPLICABLE FEDERAL, STATE AND LOCAL REGULATIONS AND STANDARDS.	
	UNITS REQUIRING APPROVAL DRAWINGS OR MODIFIED ARE NON-RETURNABLE	
	[] As drawn	[] As marked
Signed: _____		Date: _____
Printed Name: _____		
LEAD TIME WILL START UPON RECEIPT OF SIGNED APPROVAL DRAWING		

DISTRIBUTOR'S NAME:		P.O.#
VESTIL MANUFACTURING		X
DRAWN BY: B.NOTHNAGEL		DATE: 6/25/2015
REFERENCE: X		SCALE: 1:15
QUOTED LEAD TIME: X		QUOTE # X
		SALES: X
		FILE NAME: 08-007-004